

構成内容 / Components				
No.	名称 / Part name	数量 / Pcs	材質 / Material	色・表面処理 / Color・Finish
1	パネル / End panel	2	アルミ板 / Aluminium A1050P	ブラック, シルバー・アルマイト / Black, Silver・anodized
2	上カバー / Top cover	1	アルミ押出材 / Extruded aluminium A6063S-T5	ブラック, シルバー・アルマイト & クリア塗装 / Black, Silver・anodized & clear coated
3	下カバー / Bottom cover	1	アルミ押出材 / Extruded aluminium A6063S-T5	ブラック, シルバー・アルマイト & クリア塗装 / Black, Silver・anodized & clear coated
4	取付ビス(六角穴付皿 M5×10) / Screw	8	ステンレス / Stainless steel	無処理 / Unfinished
5	ゴム足 / Rubber feet	4	合成ゴム / Rubber	ブラック / Black

※ゴム足は任意の場所に貼り付けできます。
 ※Adhesive rubber feet included.

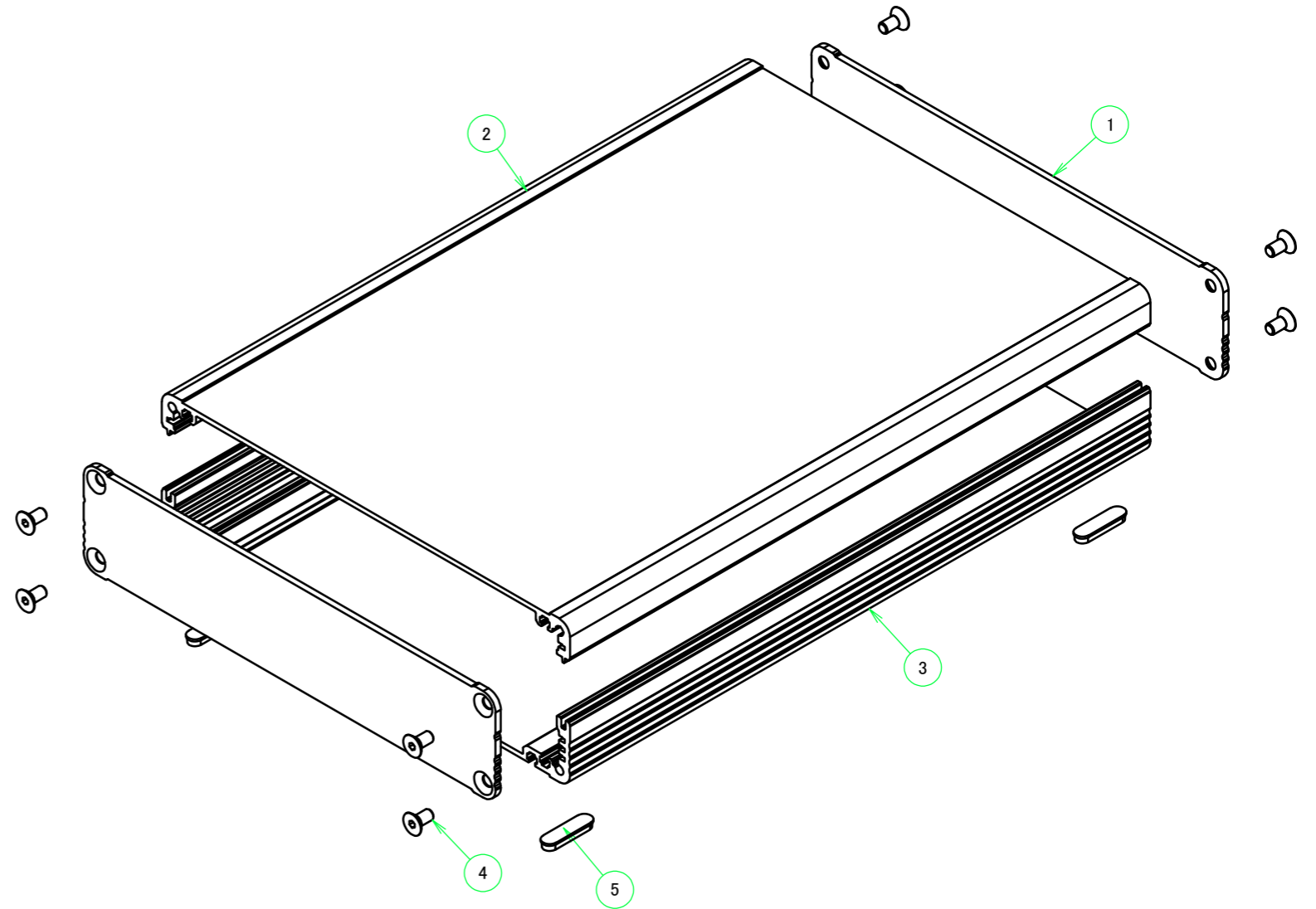
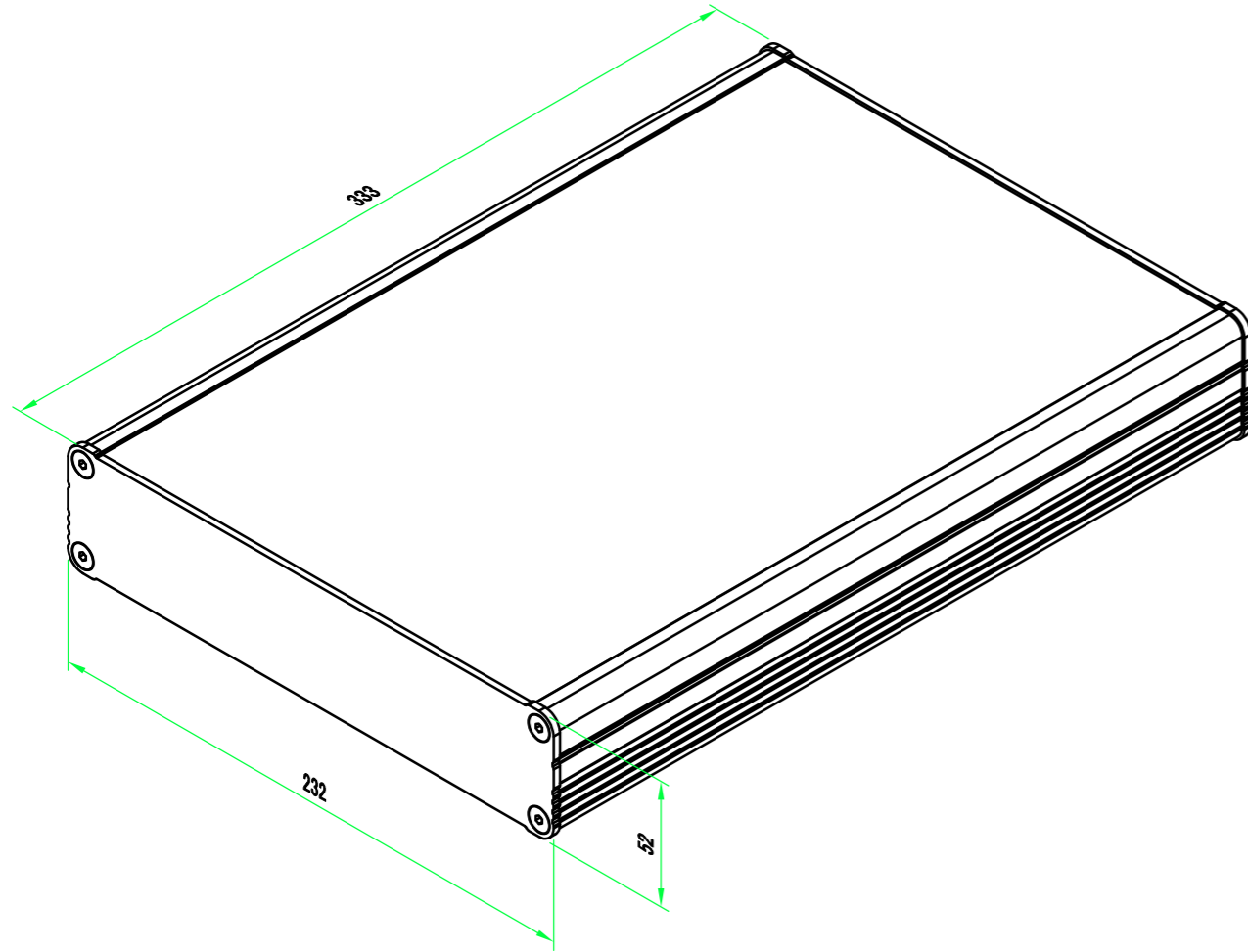

本図面および付帯する部品図の著作権は株式会社タカチ電機工業に帰属します。 / Copyright (C) TAKACHI ELECTRONICS ENCLOSURE CO., LTD. All Rights Reserved.

色仕様(型番末尾口) / Color type		
記号 / Code	上下カバー / Cover	パネル / Panel
S S	シルバー / Silver	シルバー / Silver
S B	シルバー / Silver	ブラック / Black
B S	ブラック / Black	シルバー / Silver
B B	ブラック / Black	ブラック / Black

株式会社タカチ電機工業 TAKACHI ELECTRONICS ENCLOSURE CO., LTD.			品名/Title アルミ押出材ケース EXTRUDED ALUMINIUM CASE	尺度/Scale 1 : 2.5
承認/Approved	検図/Checked	製図/Created	型番/Product number EX23-5-33□□	
中根	大江	岡本	作成日/Date 2022/11/22	1 / 5

ゴム足
Rubber feet

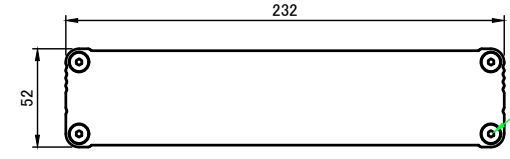
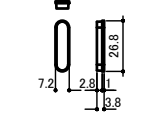

4-M5皿ビス
4-M5 Countersunk

B-B (1:4)

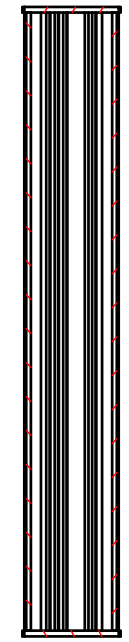

C C D

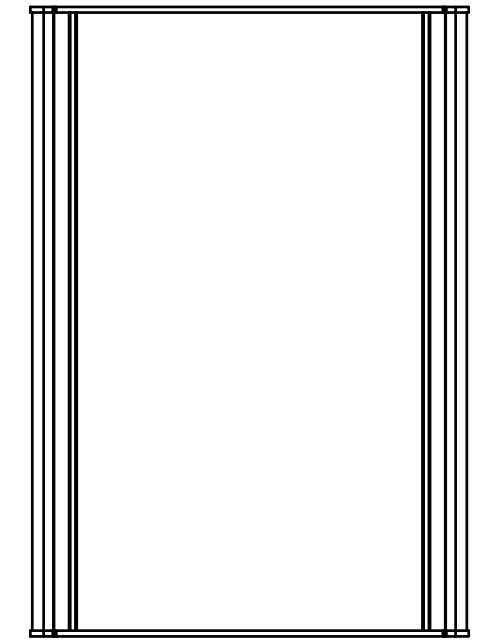
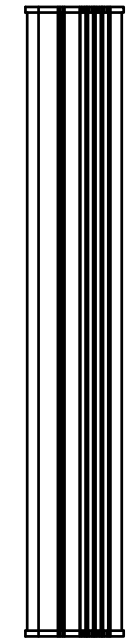
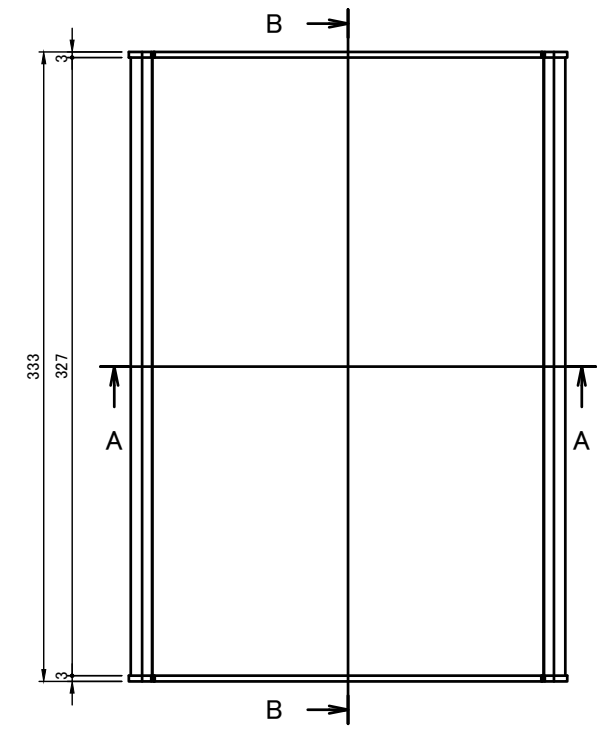
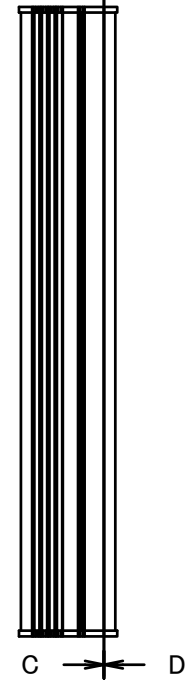

C-C (1:4)

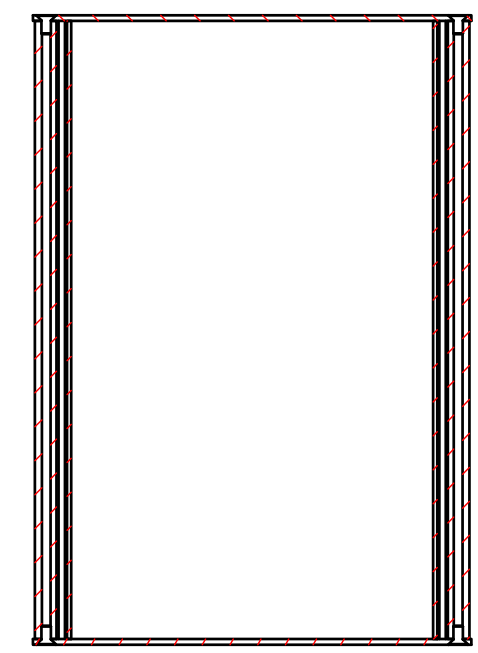

D-D (1:4)

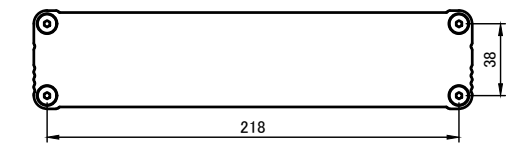
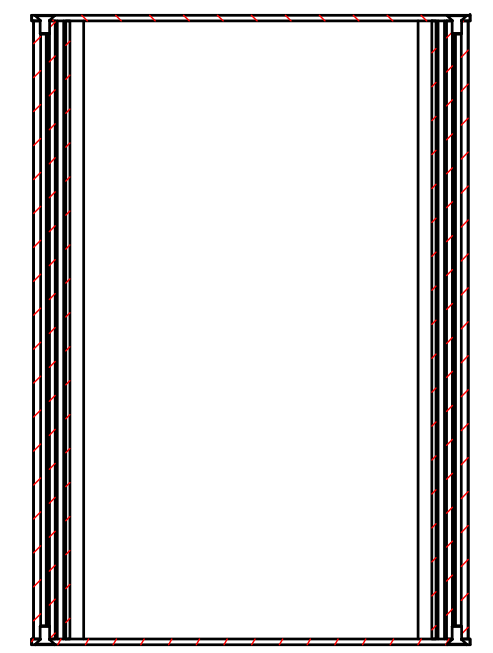

A-A (1:4)

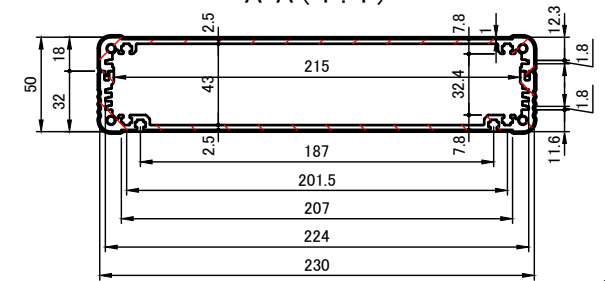

株式会社タカチ電機工業 TAKACHI ELECTRONICS ENCLOSURE CO., LTD.			品名/Title アルミ押出材ケース EXTRUDED ALUMINIUM CASE	尺度/Scale 1 : 4
承認/Approved	検図/Checked	製図/Created	型番/Product number EX23-5-33□□	
中根	大江	岡本	作成日/Date 2022/04/01	2 / 5

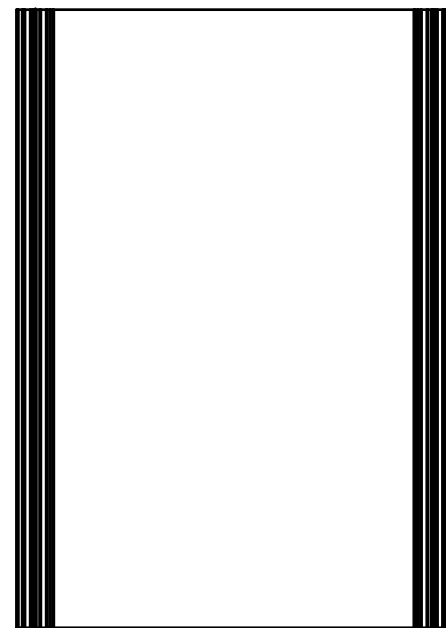
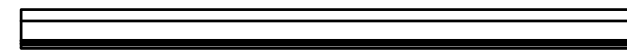
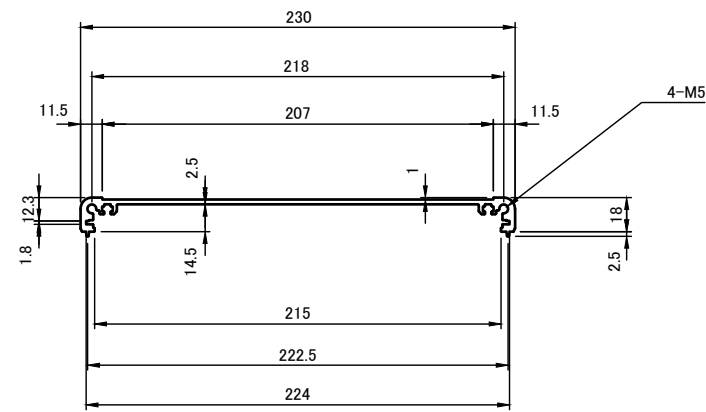
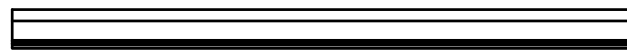
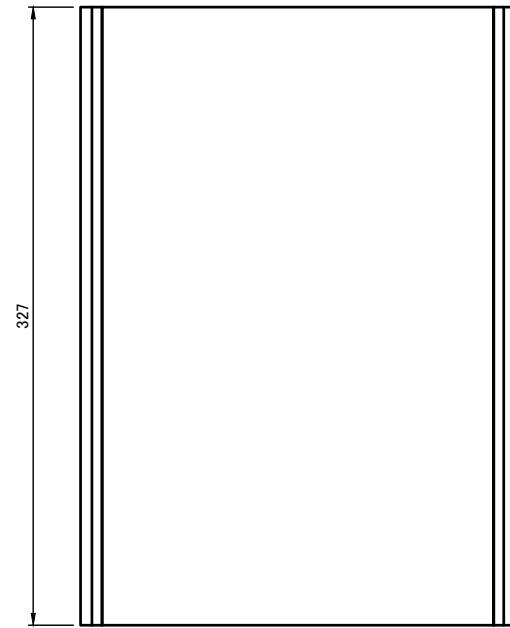

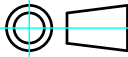
 株式会社タカチ電機工業 TAKACHI ELECTRONICS ENCLOSURE CO., LTD.			品名/Title 上カバー TOP COVER	 尺度/Scale 1:4
承認/Approved	検図/Checked	製図/Created	型番/Product number W230-D327	
中根	岡本	大江	作成日/Date 2019/01/15	3 / 5

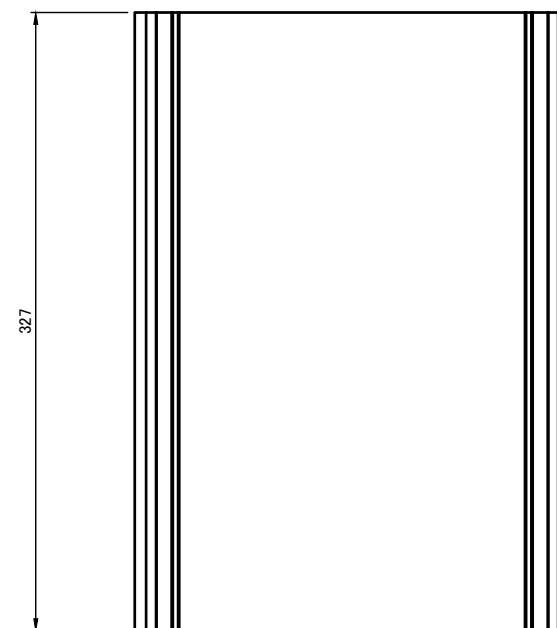
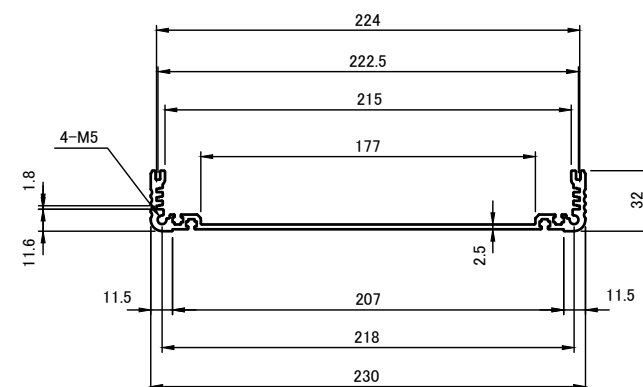

 株式会社タカチ電機工業 TAKACHI ELECTRONICS ENCLOSURE CO., LTD.			品名/Title 下カバー BOTTOM COVER	
承認/Approved	検図/Checked	製図/Created	型番/Product number W230-H50-D327	
中根	岡本	大江	作成日/Date 2019/01/15	4 / 5

パネル / End panel

B-B (1:2.5)

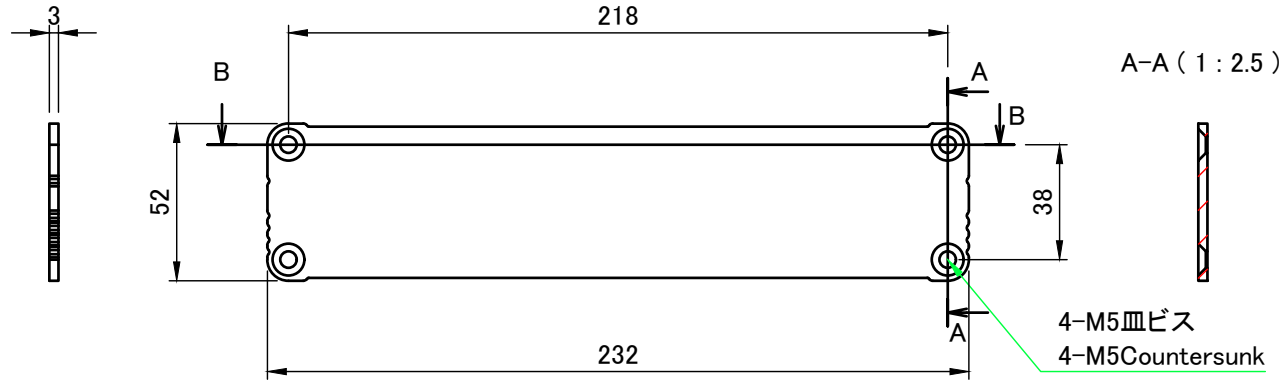

表面 / Outside

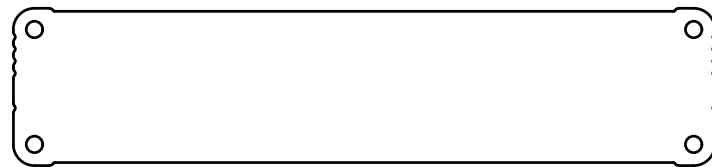
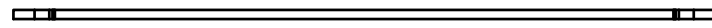

裏面 / Inside

D-D (1:2.5)

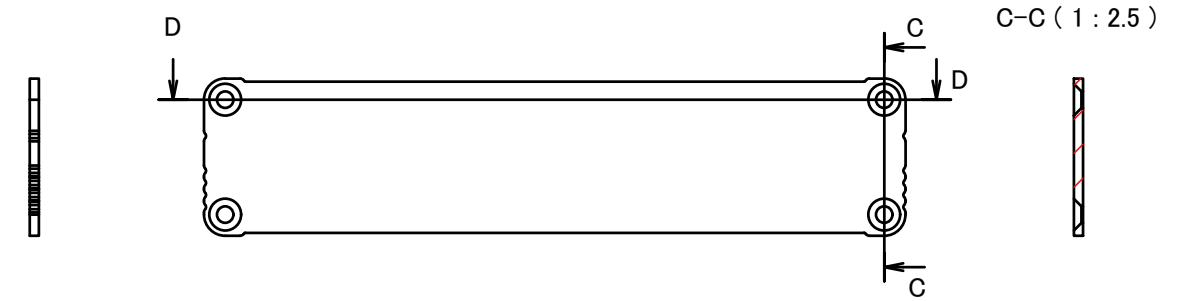

表面 / Outside

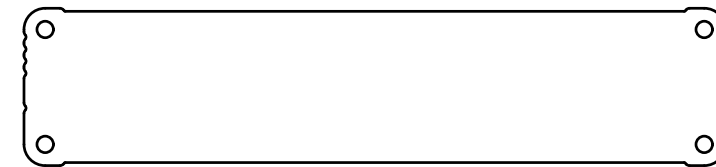
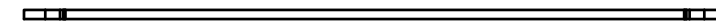

裏面 / Inside

株式会社タカチ電機工業 TAKACHI ELECTRONICS ENCLOSURE CO., LTD.			品名/Title パネル END PANEL	
承認/Approved	検図/Checked	製図/Created	型番/Product number W230 - H50	尺度/Scale 1 : 2.5
中根	大江	岡本	作成日/Date 2020/11/24	5 / 5